

# 101 つるの基本折り.

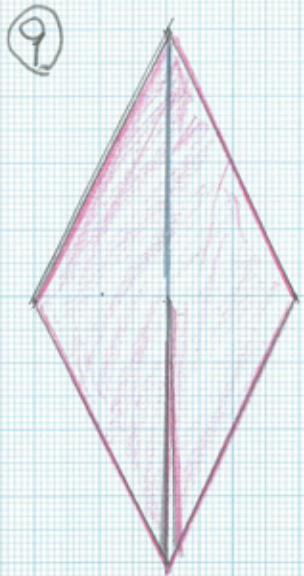

2つにわれている。

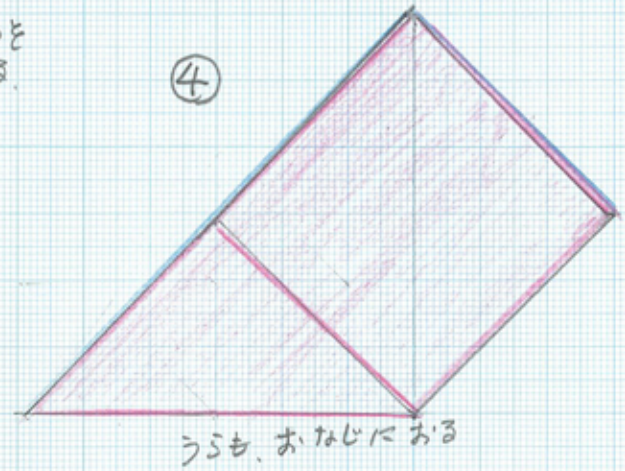
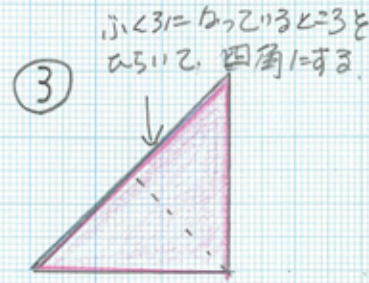
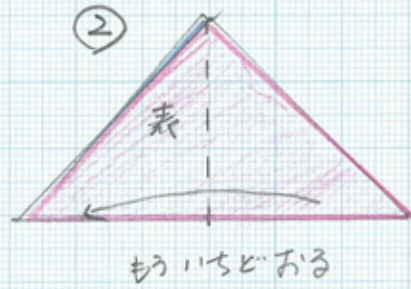
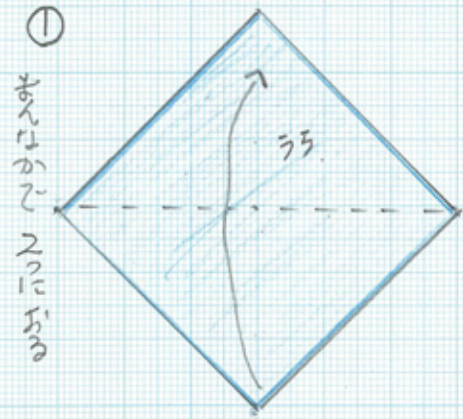
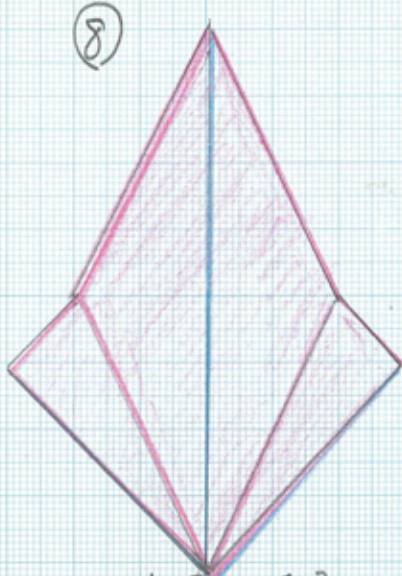

うらも同じにおる

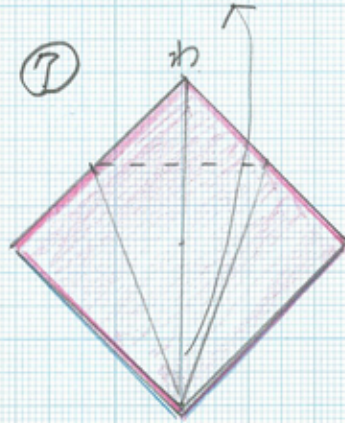

おりめにして上におくおける

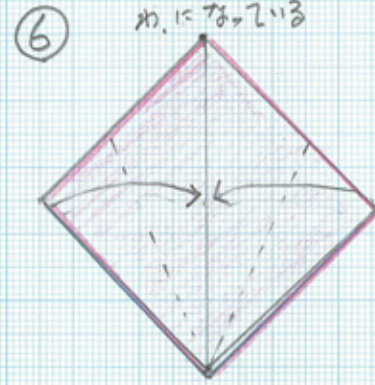

中心にあわせて おりめを  
つける。

